

ALPHA XT

(NRG1012)

MANUAL

TABLE OF CONTENTS

NOTES ON THIS DOCUMENT	2
SAFETY, INSTALLATION, AND USE	2
FURTHER INSTRUCTIONS FOR USE	3
SCOPE OF DELIVERY	4
TECHNICAL DATA.....	5
ASSEMBLY	6
PREREQUISITES.....	6
WALL MOUNTING.....	6
ELECTRICAL CONNECTION.....	7
CONNECTION TO THE MAINS	7
SETTING THE MAXIMUM CURRENT.....	8
INITIAL COMMISSIONING.....	9
OPERATION	10
LED-DISPLAY	10
LEARNING OF RFID CARDS	10
ERASING RFID CARDS.....	10
UNLOCKING THE WALLBOX.....	11
CHARGING.....	11
SEQUENTIAL CHARGING	12
RESTARTING THE BOX	12
INTERFACE RS 485.....	12
MAINTENANCE AND CLEANING.....	13
ENVIRONMENT.....	13
TROUBLESHOOTING	14
CONTACT ADDRESS	14

NOTES ON THIS DOCUMENT

Before installing and using the wallbox the instructions must be read and understood in full by the installer and each user.

Please keep the instructions for the entire service life of the wallbox in order to be able to access them later.

Also observe the operating instructions for your electric vehicle.

SAFETY, INSTALLATION, AND USE

The wallbox is only suitable for use in private and semi-public areas (e.g. company car parks).

The wallbox must not be installed in areas where there is an explosive atmosphere (EX area) or where flammable liquids or objects are stored.

The wallbox is only suitable for stationary installation. A minimum distance of 50 cm from all neighbouring objects must be maintained. Installation in a closed box is not permitted. Likewise the wallbox must not be installed in areas at risk of flooding.

The wallbox may only be installed and put into operation for the first time by a trained electrician.

The electrical connection must be made in accordance with nationally applicable standards and other national and international regulations regarding accident prevention and personal protection as well as fire protection.

The wallbox may only be connected to and operated on TT, TN-C, and TN-C-S networks. Operation on an IT network is not permitted.

Work on the wallbox may only be carried out when it is de-energised. There is a risk of fatal electric shock due to the components inside the box!

Modifications or conversions to the wallbox are not permitted and will result in the loss of any guarantee or warranty claims against the manufacturer.

The box and all associated components may only be used for their intended purpose. The manufacturer accepts no liability for personal injury or damage to property resulting from improper use.

Defective or damaged wallboxes must not be put into operation. In this case, contact your installer.

Check the function of the RCD switch regularly in accordance with national regulations.

FURTHER INSTRUCTIONS FOR USE

- Vessels containing liquids must not be placed on the charging station.
- Avoid bending or running over the charging cable.
- When the charging station is not in use, the charging cable must be coiled up on the device provided for this purpose
- When not in use, fix the charging hitch in the charging hitch holder provided.
- Before using the charging coupler, check it visually for damage or dirt on the contacts.
- The charging hitch must not be disconnected from the vehicle during the charging process.
- It is forbidden to insert objects into the charging coupler.
- Do not wash the vehicle with a garden hose or high-pressure cleaner when the charging hitch is plugged in, in order to prevent water from entering the charging hitch or the vehicle's connecting device.
- The vehicle must be parked at a suitable distance from the charging station to ensure that the charging cable can be plugged in without tension.
- Avoid direct sunlight
- Do not open an outdoor charging station during rain or snowfall.
- The charging cable must not be connected to extension cables or adapter cables.
- Do not allow children to play unsupervised in the vicinity of the charging station.
- The charging station must always be closed during operation.
- The key to open the charging station should be kept in a place where unauthorised persons cannot access it.
- For persons with a pacemaker or defibrillator, no statement can be made about the suitability of use, maintenance or repair of the charging station, despite compliance with all European directives and standards on electromagnetic compatibility. Please contact the manufacturer of the defibrillator or pacemaker for further information.
- Improper use may result in serious injury or death, and may destroy the vehicle or the charging station.

SCOPE OF DELIVERY

- Wallbox ALPHA, pre-assembled
- Key
- Jumper, pre-assembled
- Operating instructions
- Drilling template
- Fixing material, consisting of: 1x
 mounting bracket left 1x
 mounting bracket, right
 8x self-tapping screws for mounting brackets
- 2 RFID cards (additional cards available – NRG9003)

Check the scope of delivery for completeness.

TECHNICAL DATA

	ALPHA – NRG1002	ALPHA – NRG1012
Charging power mode 3 [kW] per output	3.7 (1-phase) / 11 (3-phase) 7.4 (1-phase) / 22 (3-phase)	7.4 (1-phase) / 22 (3-phase) 7.4 (1-phase) / 22 (3-phase)
Rated voltage UN [V]	230 (1-phase) / 400 (3-phase)	
Rated frequency	35	
Residual current protection AC / DC [mA]	30 / 6	
Max. current consumption [A] (adjustable)	10, 13, 16, 20, 24 or 32	
Max. charging current [A] per vehicle	16	32
Protection class	IP 65	
Protection class	I	
Impact resistance box	IK08	
Number of charging connections	2	
Charging connection/coupling	Typ 2	
Length of charging cable [m]	5.5	
Mounting location	Indoor, protected outdoor area	
Mounting type	Wall mounting, pillar mounting (optional)	
Ambient temperature	-20°C to +40°C for connected load < 11kW -25°C to +35°C for connected load > 11kW	
Altitude	Max. 2000m above sea level	
Relative humidity [%]	Max. 95 (non-condensing)	
Dimensions [mm] (W x H x D)	299 x 425 x 180 (without coupling) 299 x 425 x 380 (with coupling)	
Material	ABS, aluminium	
Weight [kg]	11	
Optionally available	NRG9000 - stand with roof NRG9001 - Roof for mounting in unprotected outdoor areas NRG9002 - RFID module NRG9003 - RFID cards	

ASSEMBLY

PREREQUISITES

The wallbox may only be installed by a trained electrician.

Before installation the device must be thoroughly checked for damage. The wallbox is only suitable for vertical installation.

The wallbox may be installed indoor or in protected outdoor areas, such as under canopies.

The ambient temperature at the installation site must be in the range of -20°C to +40°C.

The wallbox must be mounted away from easily flammable parts.

Sufficient ventilation must be ensured during operation.

The installation location must be chosen so that the connected charging cables cannot come into contact with water.

To prevent the ingress of water check the proper fit of the cover and the tight fit of the cable glands after installation.

WALL MOUNTING

1. The enclosed mounting plates (left/right) must be mounted on the back of the wallbox using four self-tapping screws each. Make sure that the bevelled tabs are oriented towards the centre of the housing (see figure 1).
2. Use the enclosed drilling template to transfer the drilling distances for wall mounting to the wall.
3. Drill holes in the wall.
4. Insert four dowels (not included in the scope of delivery) according to the wall condition.
5. Screw the two lower screws into the dowels and place the wallbox on the screws using the screw holes.
6. Screw the upper screws into the wall plugs, align the wallbox and finally fasten it using the four screws.

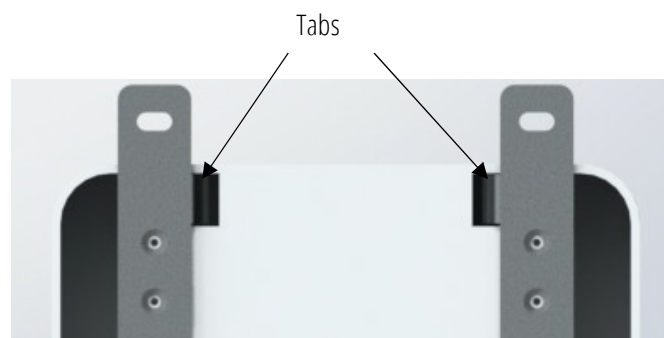

Figure 1 Arrangement of the mounting plates

The next step is the electrical connection of the wallbox.

ELECTRICAL CONNECTION

The supply line of the wallbox must be disconnected from the power supply during installation work.

CONNECTION TO THE MAINS

The supply line must be correctly fused.

1. Pull the supply cable into the box.
2. Connect the supply cable as shown in figure 2 and then relieve the strain and seal it using the cable gland.

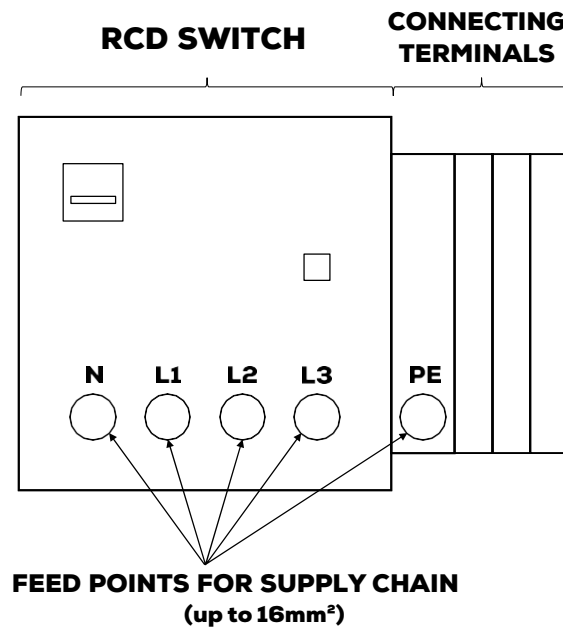







Figure 1 Connection position of the supply line

Check the electrical connection and voltages with the help of a meter.

Also make sure that neutral (blue) and earth (PE, yellow/green) are connected correctly.

VALUES FOR ALPHA NRG1012 (MAX. 22kW PER VEHICLE)

			1-PHASE LOADING			2-PHASE LOADING			3-PHASE LOADING		
			 1 cars	 2 cars		 1 cars	 2 cars		 1 cars	 2 cars	
Position connector (Jumper)	Current rating	Min. cross section supply line	(1Ph supply line or only 1Ph car)	(1Ph supply, 1Ph car)		(3Ph supply, 2Ph car)	(3Ph supply, 2Ph car)		(3Ph supply, 3Ph car)	(3Ph supply, 3Ph car)	
1	10 A	1,5 mm ²	2,3 kW	2,3 kW	0,0 kW	4,6 kW	4,6 kW	0,0 kW	6,9 kW	6,9 kW	0,0 kW
2	13 A	1,5 mm ²	3,0 kW	1,6 kW	1,4 kW	6,0 kW	3,2 kW	2,8 kW	9,0 kW	4,8 kW	4,2 kW
3	16 A	2,5 mm ²	3,7 kW	1,8 kW	1,8 kW	7,4 kW	3,7 kW	3,7 kW	11,0 kW	5,5 kW	5,5 kW
4	20 A	4,0 mm ²	3,7 kW	2,3 kW	2,3 kW	7,4 kW	4,6 kW	4,6 kW	13,8 kW	6,9 kW	6,9 kW
5	24 A	4,0 mm ²	3,7 kW	2,8 kW	2,8 kW	7,4 kW	5,5 kW	5,5 kW	16,5 kW	8,3 kW	8,3 kW
6	32 A	6,0 mm ²	3,7 kW	3,7 kW	3,7 kW	7,4 kW	7,4 kW	7,4 kW	22,0kW	11,0 kW	11,0 kW

After the charging of one vehicle is completed, the power at the other corresponds to the charging power with only one connected vehicle. Nominal values with tolerance +/- 10%

Check that the jumper is correctly seated before commissioning.

No settings are necessary to divide the charging current between two vehicles. The charging current is regulated by the control unit.

Due to the increased cable length of the supply line, it may also be necessary to compensate for the resulting voltage drop by using a larger cable cross-section.

INITIAL COMMISSIONING

1. Before commissioning the wallbox, disconnect all vehicles from the system.
2. Switch on the fuse in your house power box.
3. Switch on the RCD switch located in the box.

The microcontroller will now start automatically. Within 2 seconds, the box reports the preselected settings by flashing all LEDs. The number of flashes indicates the presetting. For example, if the LEDs flash ten times, the presetting is 10A. After successful commissioning the red LED on the control board goes out. The green LED, on the other hand, lights up permanently.

4. The door must be locked with the enclosed triangular key.

If the red LED remains permanently lit, there is a fault in the system.

In this case, the wallbox is not to be put into operation.

OPERATION

This charging station is suitable for electrically charging one or two vehicles with type 2 charging couplings. Please also refer to the operating instructions for your electric vehicle.

LED-DISPLAY

The wallbox is equipped with a separate LED indicator light for each charging cable, which shows the current status during operation.

LED-DISPLAY	DEVICE STATUS
Green	No vehicle connected, wallbox ready for operation
Blue	No vehicle connected, box locked via RFID module*.
Yellow	Vehicle connected, waiting state, charging process completed
Green, flashing slowly	Vehicle is being charged
Red, flashing	Charging cable has a short circuit, plug is very dirty
Red, flashing repeatedly 2 times	CP signal not stable, plug dirty
Red, flashing repeatedly 3 times	Diode in vehicle defective, plug dirty
3 seconds pink flashing	RFID card* not known / all RFID cards* successfully deleted
3 seconds white	RFID card* has been tuned in

The LED indicator lights also show the preset current consumption every time the box is restarted.

LEARNING OF RFID CARDS

In order to use the RFID module, it is necessary to learn at least one RFID card.

RFID-Cards can be learned as follows:

1. Open the wallbox with the key provided.
2. Press and hold the Learn button on the RFID module and place the card to be learned on the outside right of the wallbox.

A learned RFID card is indicated by a white status LED on the wallbox.

In this way, up to 100 RFID cards, possibly also from third-party providers, can be trained.

ERASING RFID CARDS

Note: It is not possible to delete individual RFID cards. The deletion process removes all previously taught-in cards.

1. First open the wallbox with the key provided.
2. Start the deletion process by pressing and holding the Clear and Learn buttons on the RFID module until the LED display flashes pink. The memory was successfully cleared.
3. Close the wallbox.

UNLOCKING THE WALLBOX

There are two ways of starting the charging process or unlocking the wallbox.

Option 1

1. Place a taught-in RFID card on the outside right of the wallbox.
The wallbox signals the unlocking with a blue LED display.
2. Establish the connection between the wallbox and the vehicle to be charged within 30 seconds.

Option 2

1. First connect the wallbox to the vehicle to be charged.
2. Then unlock the wallbox by placing the RFID card on the outside right of the wallbox.
In this case, too, the blue LED display signals that the wallbox has been successfully unlocked.

In both cases the charging process starts automatically.

Charging points to which no vehicle is connected are blocked by the wallbox after 30 seconds.

As long as the connected vehicle is waiting or charging, the connected charging point remains unlocked.

After the charging process has been completed, the charging point used is also blocked.

CHARGING

Connect your vehicle to the wallbox.

As soon as the electric vehicle is ready for charging the charging process starts automatically.

After successful charging, the vehicle ends the charging process automatically. "Overcharging" is therefore not possible.

If two vehicles are charged at the same time the wallbox regulates the available power. For example, the charging current is divided between the two vehicles. If the charging process of one of the two vehicles is completed, the charging power of the vehicle still charging is automatically increased.

SEQUENTIAL CHARGING

Note: The time-delayed allocation of the charging current is not supported by all electric vehicles.

A charging current of at least 6A is required for each vehicle to be charged.

If the wallbox has been configured for a low charging current, this may mean that not both vehicles can be charged at the same time. In this case, the two connected vehicles are charged one after the other (sequentially).

If the charging process of the second vehicle does not start automatically, it may be necessary to disconnect the vehicle from the system for a short time first. After reconnection, the charging process starts.

As a precaution, observe the connection sequence to the box. First connect the vehicle that does not support sequential charging. Only then connect the second vehicle (sequential charging is supported by this one).

RESTARTING THE BOX

To restart the box, first disconnect all vehicles from the system.

Switch off the wallbox's internal RCD for 5 seconds.

After switching on the voltage, the microcontroller of the box restarts automatically.

Within 2 seconds, the box signals the preselected setting by white flashing of the LEDs, 10 flashes signal a presetting of 10 amps.

INTERFACE RS 485

The RS 485 interface communicates with Modbus RTU, 9600 baud, 8 DATA bits, 1 stop bit, parity none, slave ID 1

Modbus Register		Default Value	Value Type
40001	Modbus ID	1	
40002	Modbus Baudrate	96	(corresponds to 9600)
40003	Max electriciy total border	255	in A
40004	Max electriciy KFZ1 border	255	in A
40005	Max electriciy KFZ2 border	255	in A
30012	Assigned electriciy KFZ1	0	in A
30013	Assigned electriciy KFZ2	0	in A
30075	Learned RFID Card (Amount)	255	
30101	Software Version RFID and Modbus Module	255	
30102	Software Version main circuit board	255	
30104	Temperature in Box	255	Value temperature sensor
30105	Last command set received from the main board	0	
30106	Last data set received from the main board	0	
30107	Status Car1	255	0 no car, 1 car connected, 2 loading request, 3 loading request with fan, 4 short circuit
30108	Status Car2	255	0 no car, 1 car connected, 2 loading request, 3 loading request with fan, 4 short circuit
30115	Set charging current supply line	255	value in A
30116	Set charging current supply line after correcting temperature and setting	255	value in A

MAINTENANCE AND CLEANING

In the event of a defect, please contact the manufacturer directly.

For safety reasons, the wallbox must be disconnected from the mains before cleaning.

Dirt can be removed with a damp cloth.

The use of harsh cleaning agents is not permitted.

The wallbox must not be cleaned with a water jet or high-pressure cleaner.

ENVIRONMENT

Dispose of the packaging material via the collection containers for paper and plastics provided for your region.

The disposal of old appliances and their accessories is carried out in accordance with the national and regional regulations for the disposal of electrical and electronic appliances. Accordingly, these must not be disposed of with household or bulky waste.

TROUBLESHOOTING

ERROR PICTURE	MEASURES
No function of the wallbox. (LEDs extinguished)	<ul style="list-style-type: none">• Check the fuses in the house distribution.• Check the RCD switch in the house distribution.• Check the internal fuses.• Check the internal RCD switch
Wallbox no longer responds.	<ul style="list-style-type: none">• First disconnect all vehicles from the system. Then restart the wallbox.
The wallbox signals a fault (red LED display).	<ul style="list-style-type: none">• Disconnect the connection to the vehicle.• Check the charging coupling and charging cable for possible damage.• In case of damage, disconnect the wallbox from the mains and repair it.• Check the contacts of the charging coupler for dirt. To do this, disconnect the box from the mains.• After repair or cleaning, the wallbox can be connected to the mains. If the fault has been rectified, the box is ready for operation.
The vehicle suddenly charges with a lower charging current or briefly interrupts the charging process.	<ul style="list-style-type: none">• The wallbox is equipped with thermal overload protection.• From around 40°C outside temperature, the system gradually reduces the maximum charging current.• If the ambient temperature continues to rise, the wallbox may switch off the charging process.• As the outside temperature decreases, the wallbox automatically continues the charging process.
The charging process was interrupted.	<ul style="list-style-type: none">• Start the charging process again. To do so, disconnect the wallbox from the vehicle for 10 seconds.

CONTACT ADDRESS

PRACHT Industry GmbH
Am Seerain 3, 35232 Dautphetal-Buchenau, Germany
Phone +49 6466 9140-900
info@prachtenergy.com, www.prachtenergy.com